

# Operating manual



**Road Racing bike**  
**Cyclocross bike**  
**Triathlon/TT bike**  
**Singlespeed/Fixie**

According to  
EN 14781

**Pedelec/e-bike**

According to  
EN 15194

**Original instruction manual**

## Dear Customer,

To start with, we'd like to provide you with some important information about your new bicycle. This will help you make the most of its benefits and avoid any possible risks. Please read this instruction manual carefully and keep it for your future reference.

Your bicycle was fully assembled and set up before you received it. If this was not the case then please contact your specialist retailer to ensure that this important work is completed.

It is assumed that users of this product have a basic and sufficient knowledge of how to use bicycles.

Everyone that:

- uses
- repairs or services
- cleans
- or disposes of

this bicycle has to understand and take note of the content and purpose of this operating manual. If you have any further questions or have not quite understood certain points, you should contact a specialist bicycle retailer for your own safety.

All information contained in this operating manual relates to the design, technology as well as care and maintenance of your bicycle. Please take note of this information, as much of it is relevant to safety. Failure to consider this information can cause serious accidents and damage to property.

As modern bicycle technology is highly complex, we have chosen to only describe the most important points.

In addition, this operating manual only applies to the bicycle with which it was supplied.

For more specific technical details, please refer to the enclosed notes and instructions from the respective manufacturers of the individual components used on the bicycle. If you are unsure about a particular point, please contact your specialist retailer.

Before riding your bicycle on public roads, you should inform yourself about the applicable national regulations in your specific country.

Firstly, here are a few important pointers as to the rider's person which are also very important:

- Always wear a suitable bicycle helmet adjusted to fit your head and wear it for every ride!
- Read the instructions supplied by your helmet manufacturer relating to fitting the helmet properly.
- Always wear bright clothing or sportswear with reflective elements when you ride. If you are riding in difficult terrain, please wear suitable protective clothing, e.g. body protectors.
- Always wear tight clothing on your lower body, and trouser clips if required. Your shoes should be grippy and have stiff soles.

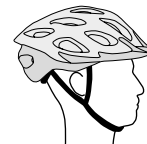

Even if you are an experienced bicycle user, please take the time to first read the chapter „Before your first ride“ and then carry out all the important checks from the chapter „Before every ride“!

Please note that as a bike rider, you are particularly at risk on public roads.

Ensure that you protect yourself and others with responsible and safe riding!

### **Note for parents and legal guardians:**

As your child's legal guardian, you are responsible for your child's actions and safety. This includes responsibility for the technical condition of your child's bicycle and adjusting it to fit your child's body size.

Please read the „Children's bicycles“ section for aspects which you and your child should always consider.

In addition, you should also ensure that your child has learnt how to use the bicycle safely. The child should know how to ride the bicycle properly and responsibly in the environment in which it will be used.





If you leave this page unfolded when you read this guide, you can immediately recognise which part of the bicycle is being referred to.

## Bicycle parts

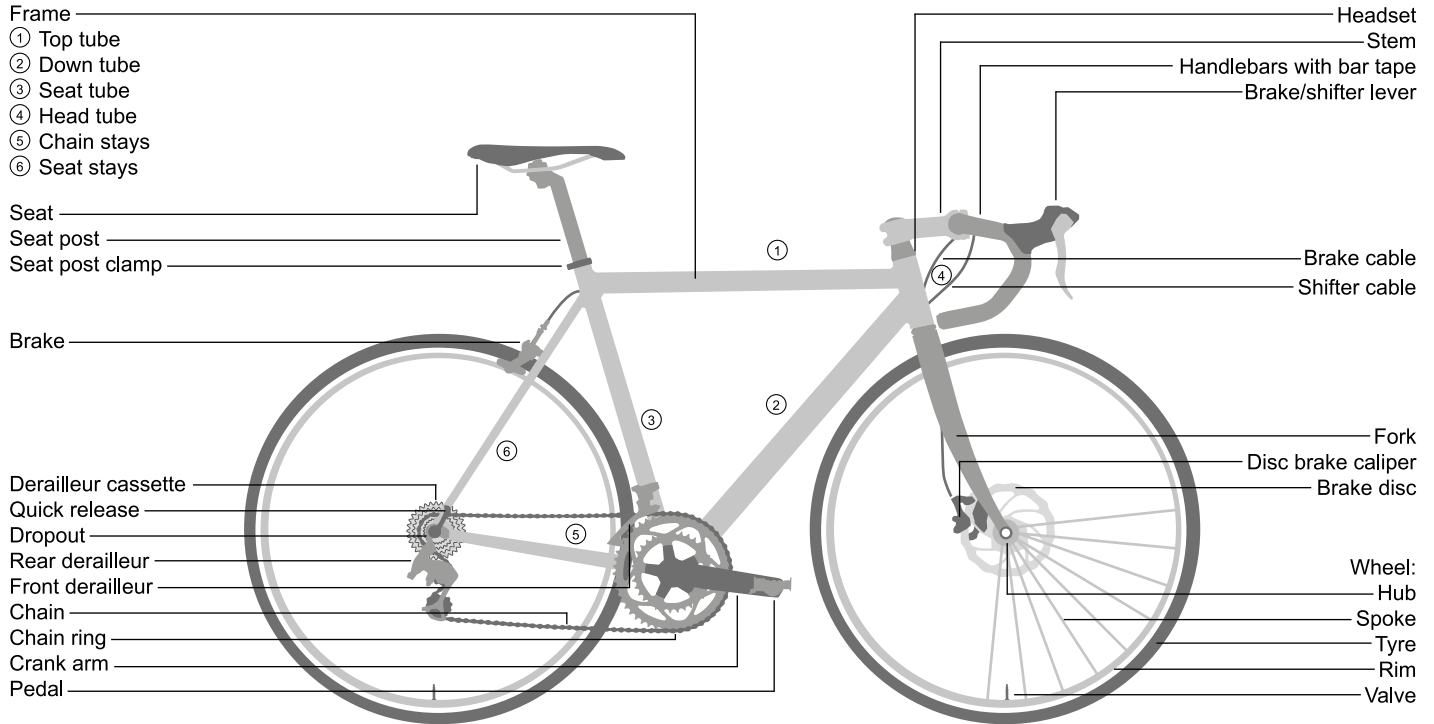

## Safety information

Please carefully read all warnings and notes in this operating manual before using the bicycle. We recommend keeping the manual close to your bicycle, so that it is always at hand.

**Please ensure you read the chapters „Before the first ride“ and „Before every ride“ before using the bicycle for the first time!**

If you lend your bicycle to a third party, please give them this operating manual with the bicycle.

This operating manual contains different types of pointers – one providing important information about your new bicycle and how to use it, a second referring to possible damage to property and the environment, and a third type warning against potential falls and serious damage, including physical injury.

If you see this symbol, there is always a risk that the danger described can occur!

The text which the warning covers always has a grey background.

Check that all quick releases are safe and secure every time you ride after your bicycle was unused, even for a short period of time! Regularly check that the bolts and components are secure.



Modern bicycle technology is high tech! Working on bicycle parts therefore requires expert knowledge, experience and specialist tools! Please do not attempt to work on the bicycle yourself! Give your bicycle to a specialist retailer for repair, servicing and maintenance!



On the left is a typical road racing bike as sold commercially. The bicycle you purchased may look somewhat different. This manual describes bicycles in the following categories: road racing bikes, cyclocross bikes, single speed/fixie, triathlon/time trial bikes as well as pedelecs/e-bikes. This operating manual only applies to the bicycle with which it was supplied.

The warnings break down as follows:



**Information:** This symbol provides information about how to use the product or highlights specific parts of the operating manual that are particularly important.



**Warning:** This symbol is aimed at warning you against improper use that could result in damage to property or the environment.



**Danger:** This symbol indicates possible dangers to your health and life that could arise if specific actions are not made or corresponding care is not taken.



**Important bolted connection!** Please adhere to the exact recommended torque when tightening this connection. The correct mounting torque is either displayed on the component or listed in the table of torques on page 22. A torque wrench has to be used to achieve the precise prescribed torque. If you don't own a torque wrench then you should always leave this work up to a specialist retailer! Parts which do not have the correct torque could fall off or break! This can result in serious accidents!

# Contents

<b>Introduction</b>	C2
<b>Bicycle parts</b>	C3
<b>Safety information</b>	C4
<b>Contents/imprint</b>	1
<b>Before the first ride</b>	2
<b>Before each ride</b>	3
<b>Legal regulations</b>	3
<b>Intended use</b>	4
<b>Adjusting the bicycle to the rider</b>	5
Using quick releases	5
Installing pedals	6
Setting up the seating position	6
Setting up the position of the handlebars/stem	7
Setting up the angle of the seat	7
Setting up the brake levers	8
<b>Children</b>	9
<b>Loose accessories</b>	9
Loose luggage rack	9
<b>Maintenance/upkeep</b>	10
Chain	10
Chain tension	10
Belt drive	11
Rims/tyres	11
Tubeless tyres	12
Tubular tyres	12
Flat tyre repair for conventional tyres	12

Brakes	15
Disk brakes	16
Gears	17
Electrical/electronic gear shifting system	17
Triathlon/TT bike	18
Disc wheels, special wheels	18
Inspection plan	19
Lubrication	21
Bolted connections	22
<b>How to use carbon components</b>	23
<b>What aspects are particularly important to consider when riding a pedelec?</b>	24
Notes on electrical and electronic components	25
Wear and warranty	26
Separate regulations for speed pedelecs/e-bikes	26
<b>Warranty and liability in the case of defects</b>	27
<b>Environmental protection tips</b>	28
<b>Inspections</b>	29
<b>Hand-over documentation</b>	C5
<b>Bicycle identification</b>	C6
<b>Notes</b>	C7

# Imprint

## Responsible for sales and marketing

inMotion mar.com  
Rosensteinstr.22  
D-70191 Stuttgart (Germany)  
Tel +49 711 35164091  
Fax +49 711 35164099  
info@inmotionmar.com  
www.inmotionmar.com

## Content and images:

Hexagon Zweiradtechnik  
Mittelstraße 4  
D-65307 Bad Schwalbach (Germany)  
Tel +49 6124 6054161  
Hexagon-Zweirad@web.de

## Legal check:

Stefan Zdarsky  
Intellectual property lawyer,  
D-60528 Frankfurt/Main (Germany)  
www.fzf.de

This operating manual covers the requirements and scope of EN 14764, 14765 and 15194.  
In the case of delivery or use of this product outside of the scope of the aforementioned areas, the manufacturer of the bicycle is required to supply the necessary operating instructions.  
© Multiplication, reprinting and translation as well as any commercial use (including extracts, in printed or digital form) is only permitted if specifically granted in writing in advance.

RR EN Edition 5.1, September 2013



## Before the first ride

Please consult the operating manuals of the individual component manufacturers, which were supplied with your bicycle or available online.

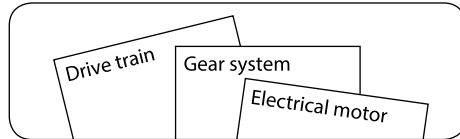

Your specialist bicycle retailer will be happy to answer any further questions you have after reading this manual.

Please ensure that your bicycle is ready for use and is adjusted to fit your body.

That means:

- Setting the position and fixture of the seat and handlebars
  - Checking the assembly and settings of the brakes
  - Securing the wheels into the frame and fork
- To ensure that you enjoy a safe and comfortable riding position, please allow your specialist retailer to set up your handlebars and stem.

Adjust the seat to a safe and comfortable position for you (see page 6).

Allow your specialist retailer to set up the brakes so that the brake levers are always within easy reach. Ensure that you know which lever operates which brake (right/left)!



Modern braking systems might be more powerful or have a different functionality than those that you are used to. Please familiarise yourself with the

brakes on a safe piece of land before setting off on your first ride with the bicycle!

If you use a bicycle with carbon fibre rims, please note that this material provides a significantly worse braking effect in combination with rim brakes than aluminium rims do!

Also remember that the effectiveness of brakes can be different than you are used to in wet conditions or on slippery surfaces. Please take the possibility of longer braking distances and slippery surfaces into account when riding!

If you are riding a single speed or a „fixie“, please familiarise yourself with its behaviour under braking before your first ride! Single speed wheels with just one brake are not permitted on public roads. Fixie bicycles cannot freewheel, which means that the pedals ALWAYS turn with bicycle's wheels.



If your bicycle has rubber or plastic cage pedals, please familiarise yourself with the grip which these offer. In wet conditions, rubber and plastic pedals can be very slippery!

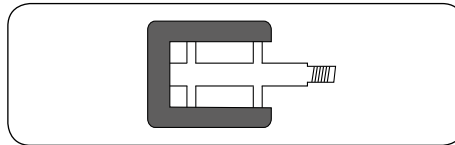

Ensure that the wheels are securely fastened in the frame and fork. Check that the quick releases and all important nuts and bolts are secure (see page 5 and 22).

Lift your bicycle up slightly and drop it onto the ground from about 10 cm in the air. If it rattles or makes another unusual noise, please ask a specialist retailer to identify and fix the problem before you ride.

Push the wheels forwards with the brakes pulled. The back brake should completely prevent the back wheel from moving, while the front brake should lift the back wheel off the ground with its braking effect. Please take an initial test ride in a safe place where you can familiarise yourself with the new brakes! Modern brakes can behave completely different under braking than those that you are perhaps used to. The bicycle's steering should not rattle under braking or exhibit any play.

Check the air pressure in the tyres. You will find instructions as to the correct tyre pressures on the sides of the tyres. Please adhere to the required minimum and maximum pressure! Where no pressure values have been stated, 6.5 bar are deemed to be a suitable pressure for racing bicycles. Cyclocrosser tyres may be pumped up to 3-4 bar.

As a general rule of thumb, when you are out on a ride, you can check the tyre pressure by doing the following: If you place your thumb on a pumped up tyre, you should not be able to significantly change its shape by applying pressure.

Check the tyres and rims. Scan them for any damage, cracks or deformations, as well as embedded particles, e.g. shards of glass or sharp stones.

If you should find any cuts, rips or holes, please refrain from riding! First have your bicycle checked over by a specialist.

## Before each ride

Before every ride, please check that:

- The brakes are working safely and are properly secured
- The cables and fittings are not leaking, if you have a model with hydraulic brakes
- The tyres are free of foreign objects and damage, and the rims are not damaged and run true, particularly after riding off road
- The tyres have a sufficient tread depth
- The suspension components are working properly and are safely secured
- All bolts, nuts and quick releases are tight (see page 5)
- The frame and fork are not misshapen or damaged
- The handlebars, stem, seat post and seat are both correctly and securely fastened as well as set up in the right position
- The seat post and seat are secure. Try turning the seat or tipping it upwards or downwards. It should not move.
- If you are using clipless/magnet pedals, please check that they are working properly. The pedals should release easily and smoothly.



If you are unsure of whether your bicycle is in a sound technical condition, take it to a specialist retailer to be checked instead of riding it!

It is particularly important if you use your bicycle a lot, either through sports riding or daily use, that you regularly have all the important parts checked by a specialist retailer.

Frame and fork, suspension components and other parts relevant to your safety such as brakes and wheels are subject to heavy

wear, which can impact the operating safety of these parts.

If you use parts for longer than their intended lifetime, these can fail without warning. This can lead to falls and serious injury!



Please make these checks before continuing after a fall or if your bicycle falls over!

Aluminium parts cannot be safely bent back into shape, while carbon components can sustain damage which is not visibly to the eye.

## Legal regulations

Before riding your bicycle on public roads, you should inform yourself about the applicable national regulations in your specific country.

This section provides information on how the bicycle has to be equipped to be permitted to participate in public road traffic.

Here you can find out which light systems have to be installed or carried with you and which brakes the bicycle has to be equipped with.

There is also an explanation of which age restrictions apply and what age riders have to be to ride where. The participation of children in public road traffic is also addressed here. If there is an obligation to wear a helmet, it is stated here.



## Intended use



Bicycles are intended for transporting one person at a time. If you are planning to transport additional people, then the regulations of the StVO apply in Germany. If you would like to transport luggage, this requires that your bicycle is fitted with suitable equipment. Children can only be transported in children's seats or trailers intended for this purpose. We recommend not taking any chances when it comes to quality in this area! Ensure that you do not exceed the maximum permissible weight.

(see page U5)



Maximum permissible weight: Rider's weight + Bicycle weight + Baggage weight

The information provided in this operating manual only applies to the types of bicycles listed on the cover.

Information on individual models is labelled accordingly.

Using the bicycle as intended also means adhering to the operating, maintenance and upkeep conditions described in this manual.

If your bicycle is equipped in line with national law, the following is permitted:

- *Cyclo-cross bikes* can be used on paved surfaces and light off-road conditions, such as field paths, as well as on marked cyclo-cross courses.

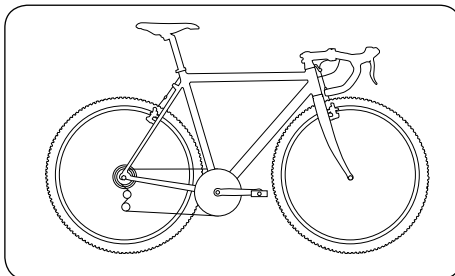

- *Racing bikes and triathlon/time trial bikes* can be used on paved roads. Use in extreme off-road conditions, e.g. in bike parks, downhill tracks or races, is only permitted with the explicit approval of the manufacturer!

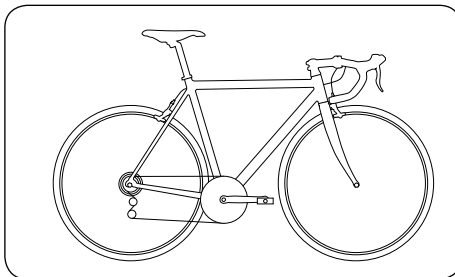

The manufacturer and retailer do not assume any liability for activities above and beyond the intended use. This particularly applies for not adhering to safety advice and damage resulting from this, for instance:

- using the bicycle in extreme off-road conditions without the manufacturer's approval,

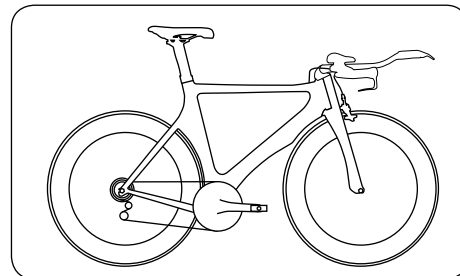

- Carrying excess weight or
- Making improper repairs to defects

Bicycles are generally not designed to withstand extreme stress, such as riding down steps or over jumps. Only bicycles which are specifically produced by the manufacturer for this purpose are suitable for this type of use.



## Adjusting the bicycle to the rider

The seat post, seat, stem and handlebars can only be tightened and secured with quick releases or bolted connections.

**i** Please ensure that you read the manufacturer's operating manual for your stem. Only allow specialists to work on your handlebars and stem, do not attempt to do this yourself!

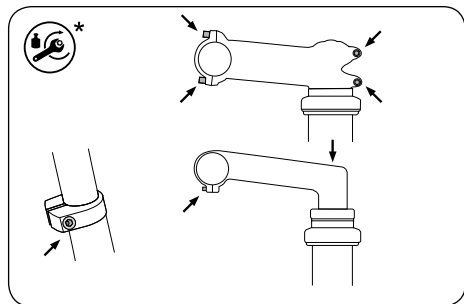

Possible positions for adjusting bolted connections

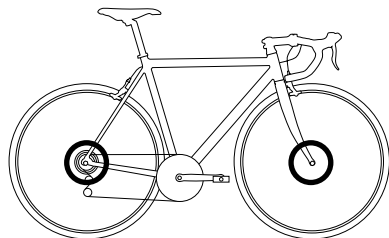

Possible positions of quick releases

## Using quick releases

Quick releases are systems installed on the bicycle in place of bolted connections. They consist of two parts: the clamping lever, which provides the necessary clamping force, and the locking nut, which allows you to regulate the clamping force. You can change the setup of your quick release when the clamping lever is open.

**i** A good gauge for measuring if the wheel is safely clamped is if you can only close the clamping lever with the balls of your hands when the resistance increases after closing the lever about half way.

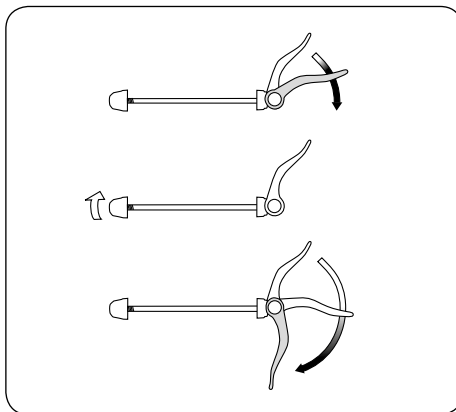

Loosening adjusting nuts



- Check that all quick releases are properly fastened before every ride.
- Check that all quick releases are still correctly secured whenever the bicycle was left unattended.
- When it is closed, the quick release lever should be flat against the frame, fork or seat post!
- When it is closed, the end of the quick release lever should always point backwards. This ensures that it cannot be opened through contact during riding.
- The quick release lever for the wheel has to be installed on the opposite side to the brake disk, otherwise you could suffer burns from the brake disk. The clamping force of the quick release can also be reduced if it is heated by the brake disk.

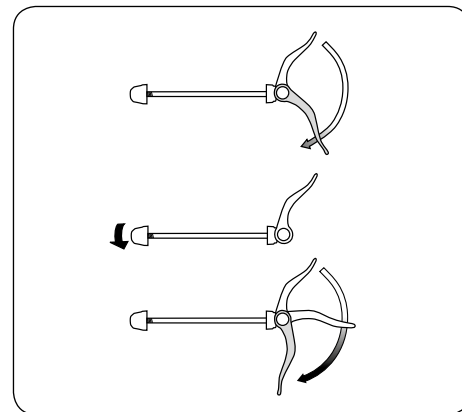

Tightening adjusting nuts

## Installing pedals

If your bicycle was supplied without the pedals pre-installed, these have to be attached with the correct wrench. Please note that the pedals have to be screwed in in different directions and secured with a high mounting torque (see page 22). Apply assembly grease to both threads.



Please read the enclosed instructions from the respective manufacturer if you use pedals feature hook or strap systems.

Practice taking your feet in and out of the hooks and operating the strap releases in a safe place. Tightened straps do **NOT** release the feet!

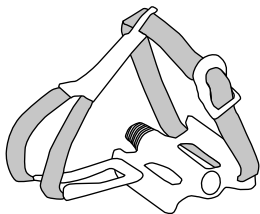

Ensure that you read the manufacturer's instructions before using magnet or clipless pedals. Practice clipping your shoes in and out of the pedals' locking system before your first ride in a quiet, safe place. Clipless pedals which do not properly release are a safety hazard.



In the case of magnet pedals, you are able to adjust how much force is required to release the shoe from the pedal. Please test this on your first ride with a setting that releases very easily! Regularly clean your magnet pedals and keep them in good condition with a suitable spray lubricant.

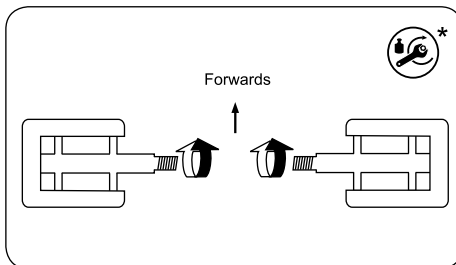

## Setting up the seating position

Before you use your bicycle for the first time, the seating position has to be set up to suit your body size. This is vital for riding safely and securely.

To do this, the seat's height, alignment and angle have to be set up, as do the height and alignment of the handlebars with the stem.

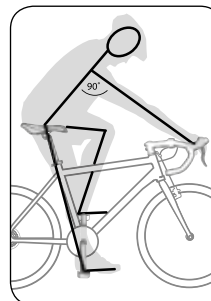

Correct seat height

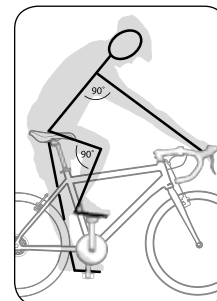

Knee joint of the upper leg at min. 90°, angle of arm 90°

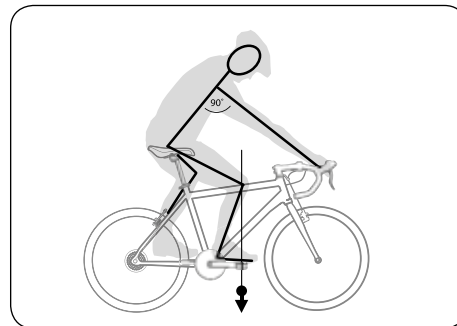

The knee should be above the axle of the front pedal

## Setting up the position of the handlebars/stem

Various types of stem are used on bicycles:

### Quill stem

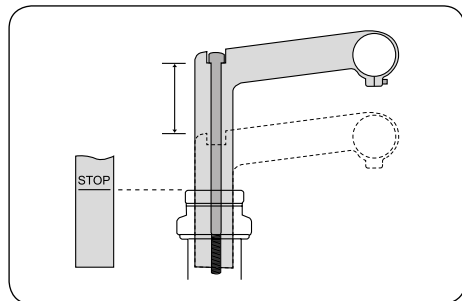

Height adjustment possible



Changing the position of the stem also changes the position of the handlebars. You should always be able to safely reach and use grips and controls. Please ensure that all cables and lines are long enough to allow you to turn the handlebars in every possible way.

### Threadless stem

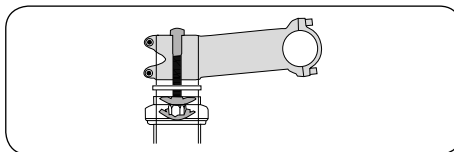

Height change possible as follows:

- Exchange of fitted spacers under or above the stem
- Turning of the stem
- Exchange of the stem



Only to be carried out by a specialised dealer

### Adjustable stem

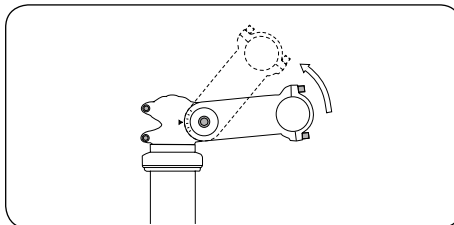

Adjustment of stem tilt possible



Please ensure that you read the manufacturer's operating manual for your stem. Only allow specialists to work on your handlebars and stem, do not attempt to do this yourself!

## Setting up the angle of the seat

When you have set the height of the seat, you have to check that the angle of the seat is suitable. In general, the upper surface of the seat should be horizontal. You can adjust this by loosening the clamping bolts in the seat post.

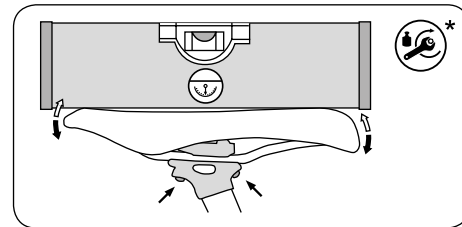

Patented seat post with two-screw locking mechanism

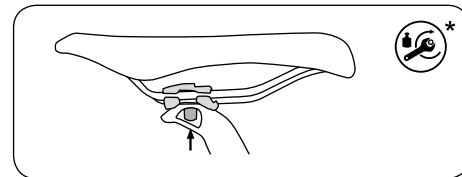

Patented seat post with one-screw locking mechanism

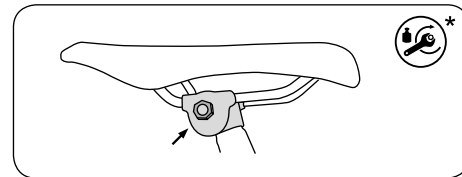

Attachment with seat clamp

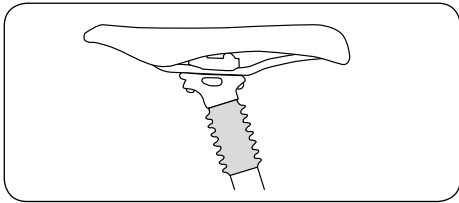

Suspension seat post

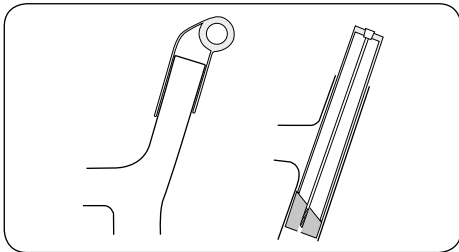

Integrated Seatpost

If your bicycle is equipped with a so-called integrated fixture: or operation and adjustment please read the enclosed instructions from the respective manufacturer.



Before you start riding, please test to see if your seat post and seat are secure. To do this, grab the seat at the front and back and attempt to turn it. It should not move.

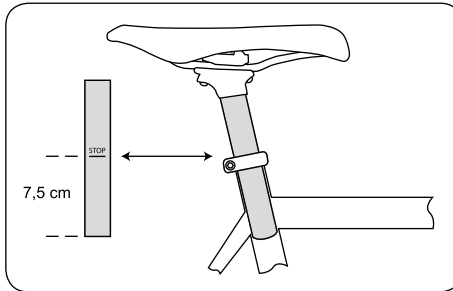

When adjusting the height of the seat, never pull the seat post further out than the maximum extension length marked! If your tube does not have a maximum marking, then you must leave a minimum insertion length of 7.5 cm.

### Setting up the brake levers

Set up your brake levers in such a way that you can safely apply them and brake comfortably. Please familiarise yourself with which lever operates which brake!

Some brakes are now equipped with power modulators. This guards against „overbraking“ and any dangerous locking of the wheels.



When you squeeze the brake levers hard or all the way to the end of their leverage, the braking force can increase sharply! Please familiarise yourself with this new braking behaviour. Ensure that you receive and read the manufacturer's operating manual.

In order to be able to apply the brake lever if you have smaller hands, in some models it is possible to position the brake levers closer to the handlebars using special equipment. For more on this, please read the enclosed instructions from the respective manufacturer.

In some models it is possible to bring the brake levers closer to the handlebars, using special devices.

Set up the cable tension in such a way that the brake levers do not touch the handlebar grip, even when they are applied to their fullest!

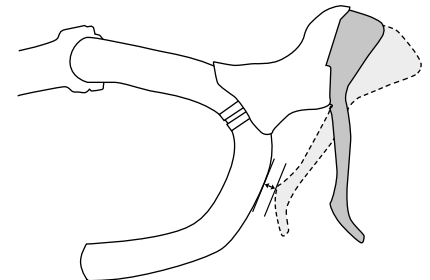

## Children



Only install children's seats on bicycles which are suitable for this kind of equipment.

Carbon fibre frames and components are not permitted to carry children's seats!

Never attach a children's seat to the seat post!

Wrap and protect all suspension and moving parts on the seat and seat post. Please ensure that your child cannot trap its fingers anywhere! This would result in a substantial chance of injury!



Only install children's trailers on bicycles which are suitable for this kind of equipment.

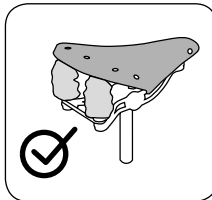
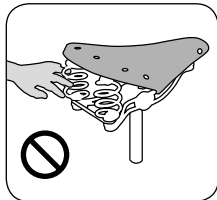
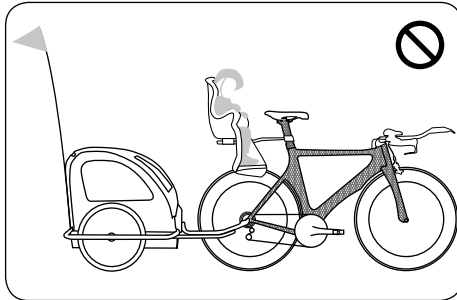

## Loose accessories

### Loose luggage rack



Only install baggage racks on bicycles which are suitable for this kind of equipment. Use only the intended fixing devices. If you own a frame or parts made of carbon, ask your specialist retailer for transportation of luggage. Don't fix racks at the seat post! It is not constructed for this use. An overload of the seat post by a rack can result in a break of the seat post and serious accidents.



Baggage changes the behaviour of your bicycle. In particular, it increases the braking distance. This can lead to serious injuries. Please adjust your riding style to this, i.e. brake earlier and anticipate more sluggish steering. Only transport baggage on racks intended for this purpose! Never attach a baggage rack to the seat post! It is not designed for this purpose. Subjecting this part of the bicycle to excess weight with a rack can lead to breaks in the seat post and serious falls!

- Only mount child seats on baggage racks if they have the corresponding holders and the manufacturers permit this.
- Please ensure that nothing can get caught in the spokes and turning wheels.



If you are riding with baggage, ensure that you do not exceed the maximum permissible weight of the bicycle (see page U5). Information on the weight capacity of the rack is also stated here.

### Front rack



Front racks are attached to the front axle or the front fork. Front racks have a strong impact on the bicycle's behaviour! Please practice riding in a safe area before riding with a loaded front rack for the first time!

# Maintenance/upkeep

**i** Please have your bicycle checked by a specialist retailer on a regular basis. These experts can identify damaged and worn parts and are able to advise you in selecting replacements. Refrain from repairing key parts yourself (frame, fork, handlebars, stem, headset, brakes, lights).

**i** **Screws and torque spanners**  
When working on the bicycle, please ensure that all screws are tightened to the correct torque. The required torque is printed on many parts with a screwed connection.

This amount is stated in Newton meters (Nm) and this work should be carried out using a torque wrench. The best sort of torque wrench for this is one that clicks when it reaches the prescribed torque. Otherwise screws can snap or break. If you don't own a torque wrench then you should always leave this work up to a specialist retailer!

A table listing the most important torques for bolted connections is provided on page 22.

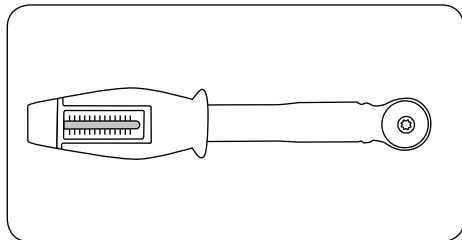

Torque spanners



## Chain

To ensure that it can work effectively, the chain has to be cleaned and greased regularly (see page 21). Dirt can be removed when washing the rest of the bicycle. Otherwise you can clean the chain by rubbing it with an oily cloth. When the chain is clean, it should be greased at the joints with suitable lubricant. After being left to soak, the excess lubricant should then be removed.

**!** To ensure that the chain and gears can work safely, the chain has to have a certain level of tension. Derailleur gear systems tense the chain automatically. In the case of hub gears which were installed without a chain tensioner, chains which are too loose have to be tightened. Otherwise they can come off and lead to a fall.

## Chain tension

**i** In the case of bicycles with adjustable dropouts, the mounting screws of the axle housing should be loosened and tightened, and not the axle nuts. If the bottom bracket shell contains an eccentric bush, please tighten the chain according to the instructions provided by the corresponding manufacturer.

**i** Please ensure that axle nuts and boosters are correctly attached!

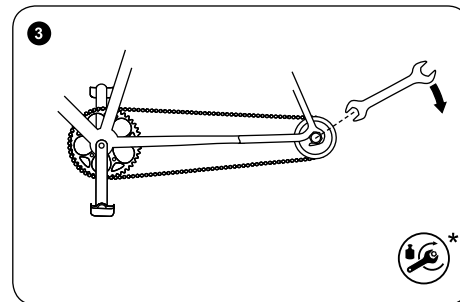
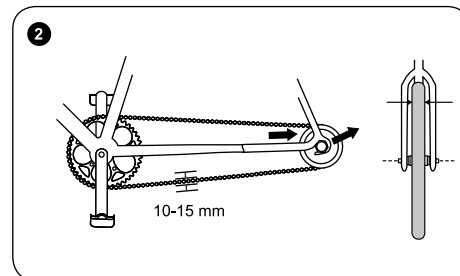
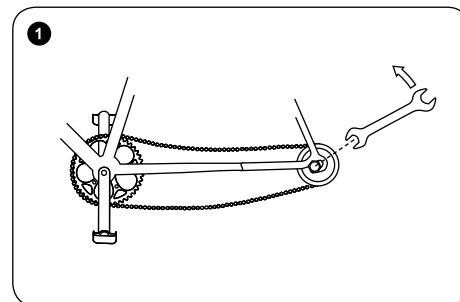

\* see page 22

**i** Dirt and permanent strain wear the chain. The chain should be replaced as soon as it can be significantly lifted (approx. 5 mm) from the front chain ring. Many modern chains for derailleur gear systems no longer have chain connectors. You therefore require specialist tools to open/change/close them. This work should be carried out by a specialist retailer.

Other chains are supplied/assembled with chain connectors. In some cases, these can be opened without the need for tools. These chain connectors can also be used to repair a damaged chain on a ride, if they have the correct width for the drive train.

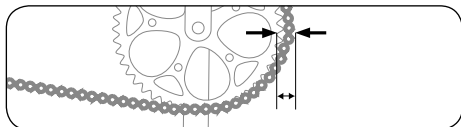

### Belt drive

**i** If your bicycle is equipped with a belt drive, please read the attached component manufacturer's operating instructions before first use.

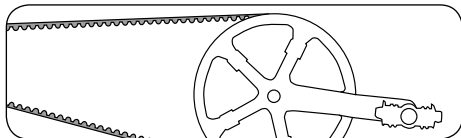

### Rims/tyres

**i** Normal operation wears down brake rubbers and brake pads. You should therefore regularly check the condition of your braking system and brake pads! Replace worn brake pads and rubbers in good time! Ensure that rims and brake discs are clean and free of any oil!

Clean the rims regularly according to the inspection plan on page 19. As part of this, you should also check the wear indicators:

**i** Modern rims (from 24") indicate when they are worn from braking. These indicators take the form of embossed or coloured points or lines on the brake surfaces of the rims. When these disappear, you are no longer permitted to use the rims. There are also similar indicators which only appear after a certain level of wear. At the very latest when two pairs of brake rubbers have been worn, it is necessary to have the rims check by a specialist retailer.

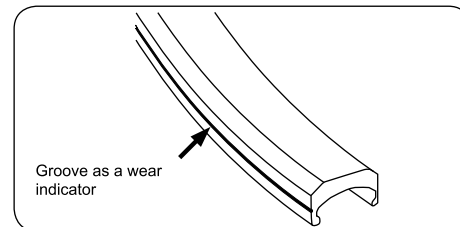

**i** Rims are subject to a great deal of strain and are vital to your safety on the bike. Riding wears rims down over time, particularly on bicycles with rim brakes. If you notice any damage or the wear indicators show dangerous levels of wear, you should no longer ride with these rims. Have them checked by a specialist retailer and replaced if required.

Wear can weaken rims and lead to falls and serious accidents.



You should also regularly check your bicycle's tyres. The minimum and maximum permitted tyre pressure is printed on the side of the tyres. Please adhere to these levels, otherwise the tyres could slip off the rims or explode!



Example of tyre pressure information



Tyres are wearable parts. You should therefore regularly check the pressure, tread and condition of your tyres. Not every tyre is designed for every type of use. Allow a specialist retailer to advise you when selecting tyres.



Your bicycle can only function safely and effectively if you replace parts with suitable, authorised replacements. Please consult your manufacturer, importer or specialist retailer for advice on suitable replacement parts.



Only replace broken or worn key parts with original replacement parts from the manufacturer or parts approved by your manufacturer. This is mandatory in the case of light systems, while the manufacturer's warranty is usually nullified if you install non-approved replacement parts.



If you install non-original or false replacement parts, this can lead to severe loss of function! Tyres with poor grip or safety, brake pads with a low friction coefficient and incorrectly installed or poorly made lightweight components can all lead to potentially serious accidents. The same applies for improper assembly!

### Tubeless tyres

If your bicycle is fitted with tubeless tyres, please read the instructions provided by your manufacturer covering the tyres and rims.



Only use tubeless tyres on rims intended for this purpose! This will be marked on the rims, with the abbreviation „UST“ for instance.



Only use tubeless tyres in the prescribed way, with the correct air pressure and the recommended sealant if required.

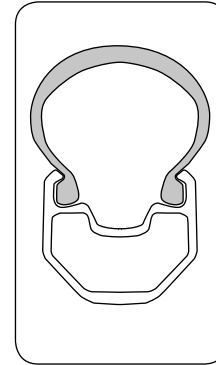

Tubeless tyres can only be mounted and removed from the rims without tools, otherwise this could lead to leaks. If the sealant is not sufficient for preventing damage, a normal tube can be used after removing the valve from the tubeless system.

### Tubular tyres

Some bicycles are also fitted with tubular tyres. For more information on these, please refer to the enclosed instructions from the manufacturer.

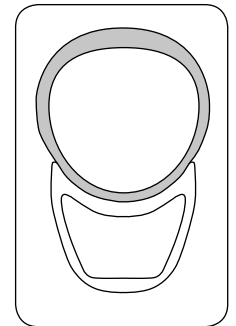





Only use tubular tyres on rims intended for this purpose! These do not have rim flanges but smoothly curving surface, from the outside inwards. This is where the tubular tyres are fitted.



Only use tubular tyres in the prescribed way and with the correct air pressure.



Attaching tubular tyres requires expert skills and lots of experience! Always have your tubular tyres changed by a specialist. Inform yourself about how to handle and change this type of tyre!

### Flat tyre repair for conventional tyres

You will require the following equipment:

- Tyre lever (plastic)
- Patch
- Rubber solution
- Sandpaper
- An open-ended wrench for wheels without a quick release
- Pump
- Replacement inner tube

### 1. Open the brake

#### Opening cantilever or V-brakes:

- Grip one hand around the wheel
- Push the brake arms against the rim
- Remove the brake line or line casing on one side

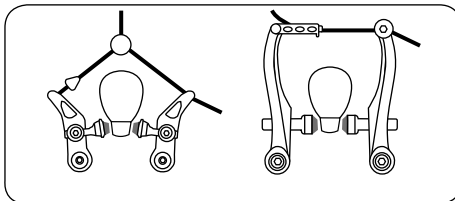

#### Removing hydraulic rim brakes:

- If your system features a brake quick release, remove the brake unit according to the instructions supplied by your manufacturer.
- If you do not have a brake quick release, deflate all of the air out of the tyre

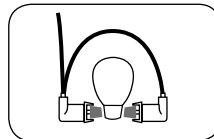

#### Opening side-pull caliper brakes:

- Open the quick release lever on the brake arm or lever, or:
- If you do not have a brake quick release, deflate all of the air out of the tyre. Now the wheel can be pulled out from between the brake pads.

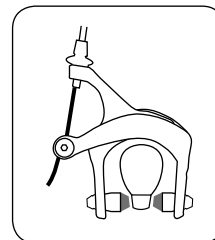

#### Disk brakes:

- The wheel can be removed without any further preparation.
- Please note: when fitting the wheel, the disk must be slotted between the brake linings of the brake calliper and ultimately be centred without contact.

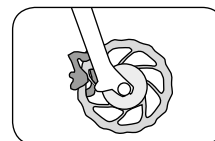

## 2. Removing the wheel

- If your bicycle has quick-release levers or axles, open them (see page 5).
- If your bicycle has hex nuts, loosen these with a suitable spanner anti-clockwise.

You can then remove the front wheel according to the steps listed above.



Make sure you don't touch the disc while taking the wheel out and in again.

Quelle: Shimano® techdocs

The following applies for rear wheels:

- If your bicycle uses a derailleur gear system, change gear to the smallest sprocket. In this position, the rear derailleur poses the least hindrance in removing the wheel.
- If your bicycle has quick-release levers or axles, open them (see page 5).
- If your bicycle has hex nuts, loosen these with a suitable spanner anti-clockwise.
- Pull the rear derailleur backwards somewhat.
- Lift the bicycle slightly.
- Lightly strike the wheel from above with the palm of the hand.
- Take the wheel out of the frame.

## Types of valve on bicycle tubes

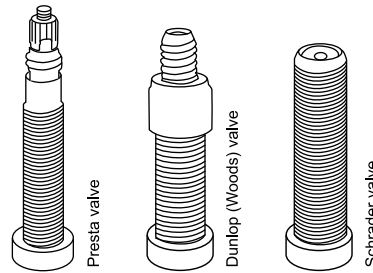

## 3. Removing the tyre and inner tube



For tube tyres, see p. 15

- Unscrew the valve cap, the fastening nut and possibly the cap nut from the valve. In the case of Dunlop or Woods valves, remove the valve stem.
- Release all of the remaining air from the inner tube.
- Insert the tyre lever opposite the valve on the inside of the tyre.
- Insert the second tyre lever approx. 10 cm from the first, between the rim and tyre.
- Lift the tyre wall over the edge of the rim.
- Repeat this lifting action around the wheel until the entire tyre is free.
- Remove the inner tube from the tyre.

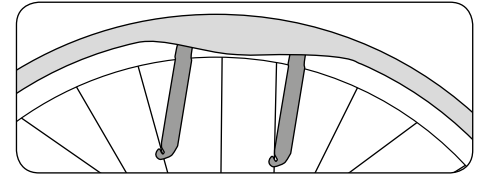

## 4. Change the inner tube

Switch the inner tube for an intact one.



For the change of tubular tyres and tubeless tyres follow the instructions of the rim or tyre manufacturer.

## 5. Reassembling the tyre and inner tube



Please avoid allowing foreign bodies inside the tyre. Ensure that the inner tube does not have any folds and is not squashed.

Ensure that the rim tape covers all spoke nipples and does not have any damage.

- Place one edge of the rim into the tyre.
- Push one side of the tyre completely into the rim.
- Insert the valve through the valve hole in the rim and put the inner tube into the tyre.
- Pull the second side of the tyre into the rim with the balls of your hands.
- Ensure that the inner tube is correctly positioned.
- In the case of Dunlop or Woods valves: Push the valve stem into the right position and tighten the cap nut.
- Pump the inner tube up somewhat.
- Check that the tyre is properly in place and runs true using the control ring on the side of the tyre. Adjust the positioning of the tyre with your hand if it does not quite run true.
- Pump the inner tube up to the recommended tyre pressure.



Please take note of the running direction of the tyre when installing it.

## 6. Reattaching the wheel

Reattach the wheel securely back in the frame or fork with the corresponding quick release, bolted connection or full floating axle mechanism.



If your bicycle has disc brakes, please ensure that the brake discs are correctly secured between the brake pads!

Read the gear manufacturer's instructions to correctly and safely assemble and set up derailleur gear systems, gear hubs and combined hub and derailleur gear systems.



Tighten all screws to the recommended torque. Otherwise the screws could break and parts could fall off (see page 22).

- Connect the brake line, attach it or close the brake quick release.
- Check if the brake pads are aligned with the brake surfaces.
- Securely attach the brake arm.
- Test the brakes.

## Brakes

Modern bicycles can be equipped with a variety of different braking systems.

There are various options:

- Rim brakes in the form of V-brakes and cantilever brakes
- Hydraulic rim brakes
- Disc brakes with hydraulic or mechanical operation



Your bicycle is supplied with the corresponding operating manual for your specific braking model. You can get more information about the brakes on your bicycle in the operating manual provided by your manufacturer or on the manufacturer's website.



Brakes are vital to your safety on the bike. You should therefore service them on a regular basis. This requires specialist knowledge and tools. Allow your specialist retailer to do this type of work on your bicycle! Work that is improperly carried out endangers your safety on the bicycle!

## Disk brakes

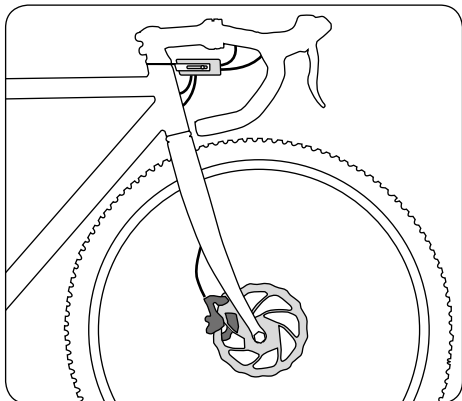

**i** If your bicycle comes equipped with a converter, which makes it possible to operate hydraulic brakes with mechanical brake levers, read the attached component manufacturer's operating instructions before using it.

**!** Various versions of disk brakes are available for racing and cyclo-cross bikes. Please always read the enclosed instructions from the component manufacturer before the first ride. Familiarise yourself with the operation and behaviour of the brakes on a safe piece of land before riding.

**i** In particular, brake disks and brake pads are subject to wear. Please allow a specialist retailer to check these key parts on a regular basis and replace any worn parts if necessary.

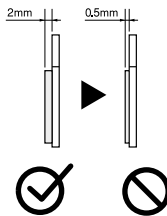

Source: Shimano® techdocs

**i** Please do not touch the brake disk while it is rotating or directly after braking. This could result in injury or burns.



Source: Shimano® techdocs

## Hydraulic disk brakes

Hydraulic disk brakes can be operated with conventional brake/shift levers using various adapters. When working on the stem and headset, particular attention should be paid that the adapters are securely attached and are working correctly.

## Vapour bubbles

**i** Avoid permanently braking for longer periods, as can be the case during long, steep descents. Otherwise this can allow vapour bubbles to form and cause a complete failure in the braking system. This could result in serious falls and injury.

The brake lever may not be applied if the bicycle is on its side or upside down. Otherwise air bubbles can enter the hydraulic system which could cause the brakes to fail. After transporting the bicycle, check if the pressure point of the brakes seems softer than it was before. Then apply the brakes slowly several times. This allows the braking system to discharge any bubbles. If the pressure point remains soft, please refrain from riding. A specialist retailer has to then discharge the air from the brake system.

**i** You can avoid this problem by applying the brake lever before transport and then fixing it in this position using a strap. This prevents any air from entering the hydraulic system.

When you come to cleaning the braking system, please first read the instructions provided by the component manufacturer.

### Gears

Modern bicycles can be equipped with a variety of different gear systems.

The gear lever can be operated as shown in this example:

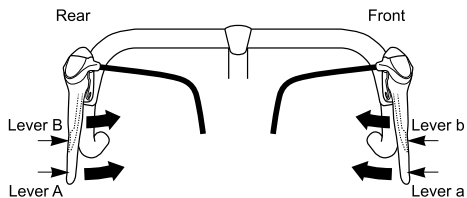

- Lever (A): Changing to a larger rear sprocket.
- Lever (B): Changing to a smaller rear sprocket.
- Lever (a): Changing to a larger chain ring.
- Lever (b): Changing to a smaller chain ring.

All levers return to their original position after being released.

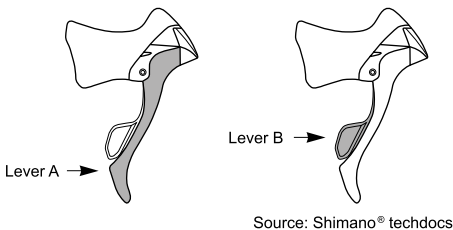

**i** Your bicycle is supplied with the corresponding operating manual for your specific gear system. You can get more information about the gears on your bicycle in the operating manual provided by your manufacturer or on the manufacturer's website.

**i** Gears are vital to your safety on the bike! Please read the operating instructions supplied to you by your manufacturer and familiarise yourself with how to operate the bicycle and switch gears before your first ride. Allow your specialist retailer to undertake any work on your bicycle's gears! Work that is improperly carried out endangers your safety on the bicycle!

### Electrical/electronic gear shifting system

If your bicycle is equipped with a gear system which sends its shifting signals electronically: For operation and upkeep read the enclosed instructions from the respective manufacturer.

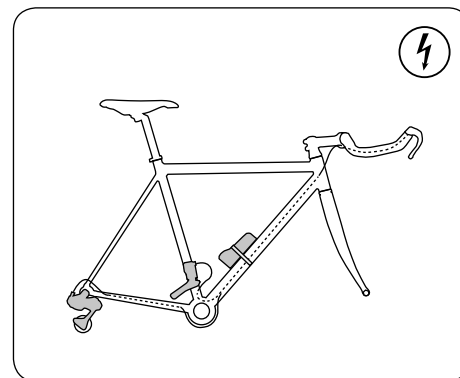

## Triathlon/TT bike

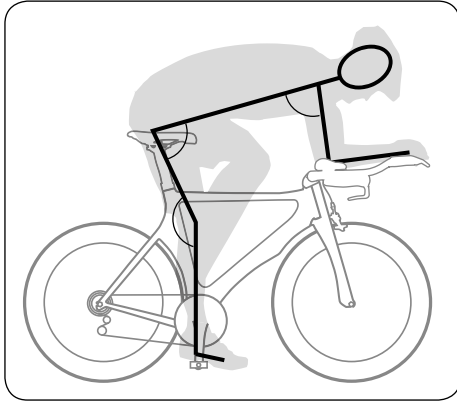

position for TT and triathlon



The seat and handlebar position of time trial and triathlon bikes is considerably different from that of conventional racing bikes. Please allow specialists to advise you on the seating position of your time trial or triathlon bike.

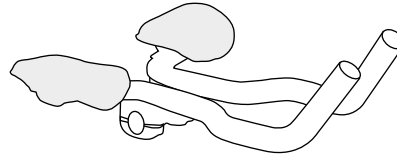

Time trial/triathlon handlebar attachment



The behaviour of a bicycle with a TT handlebar or attachments can be dangerously different to what you are used to. The movement required of the hands from the time trial position to the brake or gear handles is also longer and unfamiliar. Please practice this in a safe area until you have mastered the controls of the bicycle.

## Disc wheels, special wheels

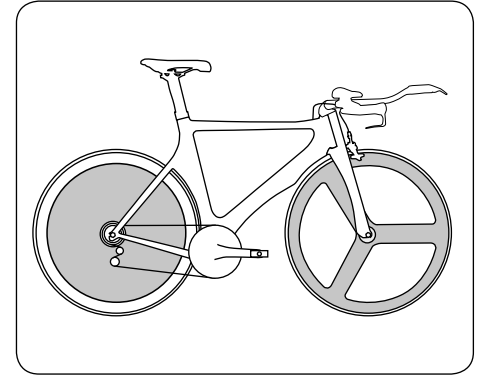

If your bicycle has disk wheels, tri-spokes or other types of wheels, please ensure that you familiarise yourself with how to handle and care for them.



Special wheels can behave differently than you are used to when riding, braking and steering. Tri-spokes and disk wheels in particular are more sensitive to wind than conventional wheels. Rims made of something other than aluminium can provide different, and perhaps considerably less effective, braking than you are used to.

Familiarise yourself with your new bicycle and its behaviour in a safe, quiet area.

## Inspection plan



Modern bicycle technology is highly efficient but also sensitive. You should service your bicycle on a regular basis. This requires specialist knowledge and tools. Allow your specialist retailer to do this type of work on your bicycle! You can get more information about your bicycle's parts as well as cleaning and maintenance in the operating manual provided by your manufacturer or on the manufacturer's website.

Work which you are able to carry out yourself with no risk to safety is printed in **bold**.

To ensure that your bicycle remains in a safe condition and fulfils the conditions of the warranty, the following terms apply:

- Clean your bicycle after every ride and check it for possible damage.
- Allow a specialist retailer to carry out inspections.
- Check your bicycle every 300 - 500 km or every three to six months.
- Check that all screws, nuts and quick releases are secure.
- Use a torque spanner to tighten screw joints!
- Clean and grease moving parts (excluding brake surfaces) according to instructions from the manufacturer.
- Allow a specialist retailer to touch up any paint damage.
- Ask a specialist retailer to replace any broken and worn parts.

## Schedule and inspection work

### Before every ride:

Work undertaken

Maintenance/inspection:

Check the following:

- **Spokes**
- **Rims for wear and concentricity,**
- **Tyres for damage and foreign bodies**
- **Quick releases**
- **The functionality of the gears**
- **The functionality of the brakes**
- **Hydraulic brakes for possible leaks**
- **tubular tyres and tubeless tyres: properly secured and correct tyre pressure**

After riding 200 kilometres from purchase, then at least once a year:

Work undertaken

Check the following:

- **Tyres and wheels**

Torques:

- Handlebars
- Cranks
- Seat post
- Pedals
- Seat
- All mounting screws

Make possible adjustments to the following components:

- Headset
- Gears
- Brakes



### Every 300 to 500 kilometres:

Work undertaken

Prüfen:

- **Chain**
- **Sprockets**
- **Gearside**
- **Belt drive**
- Rims
- Brake pads for wear, replace them if required

Clean:

- **Chain**
- **Gearside**
- **Sprockets**
- **Belt drive**

Grease:

- **The chain with suitable lubricant**

Check the following:

- All screw joints are secure

### Every 3000 kilometres:

Work undertaken

Have the following checked, cleaned or replaced by your specialist retailer:

- Hubs
- Pedals
- Headset
- Gears
- Brakes

### After rides in the wet:

Work undertaken

Clean and grease:

- **Gears**
- **Chain**
- **Brakes (excluding brake surfaces)**

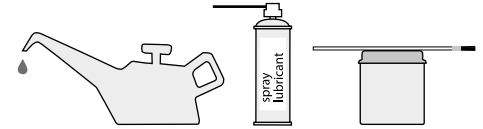

Ask your specialist retailer for suitable lubricants! Not all lubricants are designed for all purposes. Using the wrong lubricants can lead to damage and impact the part's performance!



The first inspection is particularly important for ensuring that your bicycle remains safe and problem-free! Cables and spokes stretch, while bolted connections can loosen. Therefore always allow a specialist retailer to carry out the first inspection.



## Lubrication



Working on the bicycle requires special knowledge, experience and special tools! Only allow specialists to work or check key parts on the bicycle!

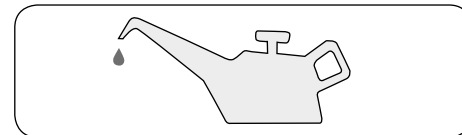

## Lubricant schedule

What should be greased?	How often?	With which lubricant?
Chain	After cleaning off any dirt, after riding in the wet, every 250 km	Chain lubricant
Brake and shifter cables	When their performance deteriorates, once a year	Silicon-free lubricant
Wheel bearings, pedal bearings, bottom bracket	Once a year	Bearing grease
Threads during assembly	During assembly	Assembly grease
Contact surfaces of carbon parts	During assembly	Carbon assembly paste
Sliding surfaces of quick releases	Once a year	Grease, spray lubricant
Metal seat post in metal frame	During assembly	Grease
Links in the gear system	When their performance deteriorates, once a year	Spray lubricant
Brake links	When their performance deteriorates, once a year	Spray lubricant

## Bolted connections



It is vital that all bolted connections on the bicycle have the correct torque in order to ensure that they are secure. Too much torque can damage the screw, nut or component. Always use a torque spanner to tighten screw joints. You are not able to correctly tighten these bolted connections without this specialist tool!



If a component specifies a torque for its bolted connections, then this should be strictly adhered to. Please read the instructions provided by the manufacturer, which lists the correct mounting torques.

<i>Bolted connection</i>	<i>Torque</i>
Crankset arm, steel	30 Nm
Crankset arm, aluminium	40 Nm
Pedals	40 Nm
Front wheel nut	25 Nm
Rear wheel nut	40 Nm
Stem expander bolts	8 Nm
Threadless stem clamping bolts	9 Nm
Seat post clamping bolt M8	20 Nm
Seat post clamping bolt M6	14 Nm

<i>Bolted connection</i>	<i>Torque</i>
Seat post bar	20 Nm
Brake blocks	6 Nm
Dynamo attachment	10 Nm
Seat clamp on carbon frames	5 Nm*
Drinks bottle holder on carbon frames	2 Nm

### Differences for carbon components:

<i>Bolted connection</i>	<i>Torque</i>
Front derailleur bracket attachment screw	3 Nm*
Shift lever attachment screw	3 Nm*
Brake lever attachment screw	3 Nm*
Handlebars - stem clamping	5 Nm*
Stem - fork tube clamping	4 Nm*

<i>Bolted connection</i>	<i>Thread</i>	<i>Torque Max.</i>
Seat clamp, loose	M 5	4 Nm*
Seat clamp, loose	M 6	5,5 Nm*
Derailleur hanger	M 10 x 1	8 Nm*

<i>Bolted connection</i>	<i>Thread</i>	<i>Torque Max.</i>
Drinks bottle holder	M 5	4 Nm*
Bottom bracket	BSA	according to manufacturer's instructions*
Brake caliper, disk brake, Shimano (IS and PM)	M 6	6 – 8 Nm
Brake caliper, disk brake, AVID (IS and PM)	M 6	8 – 10 Nm
Brake caliper, disk brake, Magura (IS and PM)	M 6	6 Nm

### General torque for bolted connections

In general, the following torques can be used for bolted connections:

<i>Dimensions</i>	<i>Screw quality</i>			<i>Unit</i>
	8.8	10.9	12.9	
M 4	2,7	3,8	4,6	Nm
M 5	5,5	8,0	9,5	Nm
M 6	9,5	13,0	16,0	Nm
M 8	23,0	32,0	39,0	Nm
M 10	46,0	64,0	77,0	Nm

\* Use of carbon assembly paste is recommended



## How to use carbon components



If you have a carbon frame or parts, these should not be applied with grease or oil. Please use special assembly paste for carbon parts.

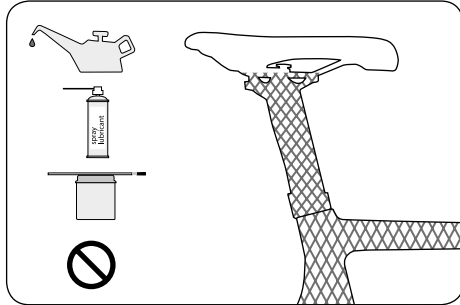

Carbon is a material which requires special handling and care during construction, servicing, riding, transport and storage.

### Properties



Carbon parts cannot be bent, dented or misshapen after an accident/fall. If this is the case, it is possible that the fibres have been destroyed or have broken off, e.g. within the part, which is not visible from the exterior!

Therefore, it is vital to regularly check carbon frames and other carbon components very carefully, especially after a fall or an accident.

- Look for splinters, tears, deep scratches, holes or other changes in the carbon surface.

- Check if the parts have got softer or less stiff than usual.
  - Check if individual layers (paint, finish or fibres) come off.
  - Listen for any cracking or other usual sounds.
- If you are not completely certain that your bicycle is in perfect condition, please allow a specialist retailer to check the affected carbon parts!



Some carbon components require lower torques than metal parts. Excessive torques can lead to hidden damage, which is possibly not visible from the outside. Frames or components can break or warp to such an extent that you could fall. Therefore please always adhere to the instructions supplied by the manufacturer or ask for advice from a specialist. Always use a torque spanner to ensure that you get the required torque. Carbon parts may not be applied with grease or oil. Special assembly paste is available for assembling and safely securing carbon components with a low mounting torque.

Never expose carbon parts to high temperatures! Even in the back of cars, the sun's rays can generate such a heat that it can put the safety of carbon parts at risk.

Do not clamp a carbon frame directly into a work stand, instead you should secure it by the seat post. If the seat post is also made of carbon, use another tube made of metal.

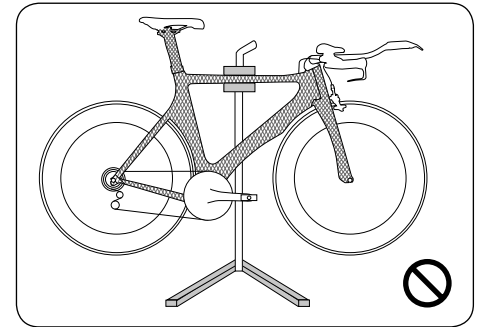

Carbon =



# What aspects are particularly important to consider when riding a pedelec?

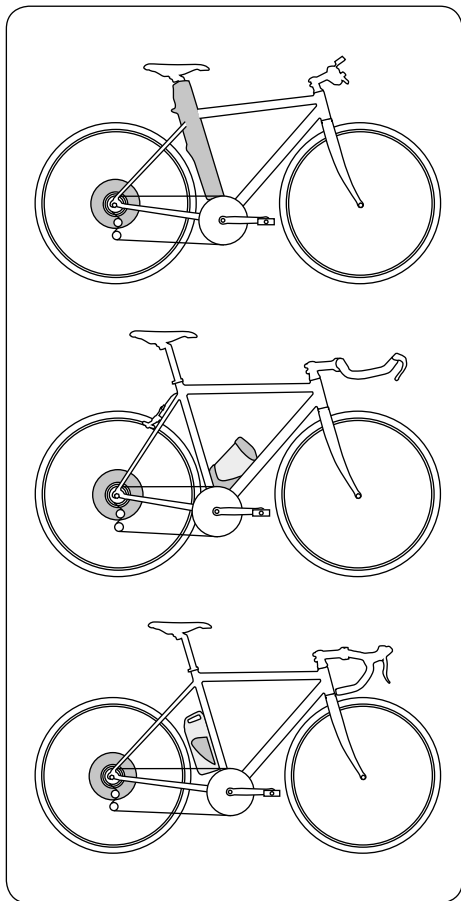

Rear wheel hub motor

If you have bought a pedelec, all bicycle-related topics are described in the previous pages of this operating manual.

The regulations, rules and technical aspects of riding a pedelec specifically will be described in the following section.

For more information on operating your pedelec and technical details, please refer to the enclosed instructions from the manufacturer of the individual components.

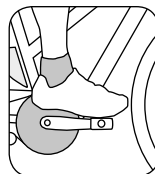
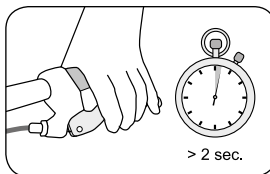

Always apply the pedelec's brakes **before** you set foot on the pedal! The motor drives as soon as you push the pedal. This force is unfamiliar and can lead to falls, danger or accidents in traffic, which could result in injury.



Practice operating and riding your pedelec in a quiet and safe place before you take to public roads!

## Legal regulations:



Please inform yourself about the applicable national regulations in your specific country!

Pedelecs fall under the jurisdiction of the same EU laws as a normal bicycle. In the EU, the use of cycle tracks is subject to the same laws as bicycles. Outside of the EU, as well as in some regions within the EU, special regulations could apply. Please inform yourself about the applicable national requirements.



The motor is only allowed to support the rider when he or she is actually turning the pedals. The central motor capacity is capped at 250 W and the support has to switch off at 25 km/h.

- No obligation to hold either insurance or a driving licence. Making helmets compulsory is currently being discussed, please inform yourself about the applicable regulations before using your bike. However, we strongly recommend wearing a suitable bicycle helmet.

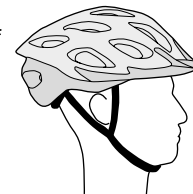

Your pedelec may have a so-called „pushing aid“ or your specialist retailer can equip your bicycle with this feature, which allows your pedelec to travel up to 6 km/h, without you having to pedal.



If your pedelec/e-bike does not have a dynamo, you will also have to carry the sufficiently loaded battery of your pedelec along with you whenever you ride without electrical support. However, a dynamo is required if you have to ride with lights.

 The regulations governing the performance of a pedelec and the connected requirements relating to minimum age, driving license, registration and helmet regulations may differ between countries. The same applies for the obligation to use cycle paths. Please inform yourself about the applicable legislation.



### Notes on electrical and electronic components

 Your pedelec is supplied with the corresponding operating manual for the integrated motor from the component manufacturer. Information on operating, maintaining and cleaning your bicycle as well as technical information is included in this manual as well as on the website of the respective component manufacturer.



The electrical motor in your pedelec is very powerful. To operate it correctly and safely, it is necessary to have it serviced by a specialist retailer on a regular basis. Immediately remove the battery if you identify any damage to the electrical system or see live parts exposed after a fall or accident. Always consult a specialist retailer if you require repairs, want to ask about a question or problem, or have identified a defect. Having a lack of specialist knowledge can result in serious accidents!

### Loading process

In some models you can charge the battery while it is mounted in the Pedelec. Please read the component manufacturer's operating instructions in this regard.

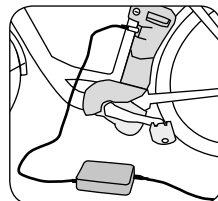

### Charger:

- Only use the original charger or another one approved by the manufacturer.
- Only use the charger in dry rooms and do not cover it when it is turned on. This could lead to a short-circuit and a possible fire hazard.
- When cleaning the charger, always first unplug the device.

### Maintenance and cleaning:

- Servicing and cleaning work on live parts should only be undertaken by a specialist retailer!
- Only replace parts of your pedelec with original parts or those approved by the manufacturer. This could otherwise nullify any guarantee and warranty claims.
- Before you clean your pedelec, please remove the battery.
- When you clean the battery, ensure that you do not touch the contacts and connect them accidentally. If these contacts are live, you could be injured and damage the battery.
- Cleaning your pedelec with a high pressure cleaner can damage the electrical systems. The high pressure can force cleaning fluid into sealed parts and damage them as a result.
- Avoid damaging cables and electrical components. If this happens, you should not ride the pedelec until it has been checked over by a specialist retailer!



Do not allow children to use the pedelec unattended and without detailed instruction! Ensure that children understand the dangers of using electrical devices.

## Wear and warranty

Please note that the parts of a pedelec are subject to higher levels of wear than a bicycle without an additional integrated motor. This is due to the heavier weight of the pedelec and higher average speed from the motor. This increased wear is not a material defect and is not covered by the warranty.

Typically this definition of wear includes the following parts

- Tyres
- Brake pads
- Chain
- Spokes

The battery is subject to aging and is therefore also a wearable part. Please note that the battery gradually loses its capacity depending on its age and operating life. Take this into account when planning journeys and ensure that you switch to a new battery in good time. Replacement batteries can be purchased from your specialist retailer.

## Separate regulations for speed pedelecs / e-bikes

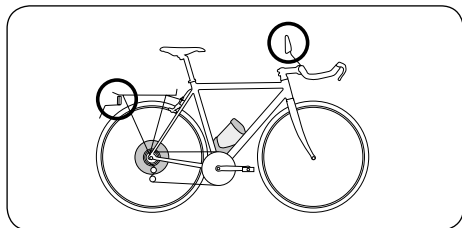

If your bicycle supports speeds faster than 25 km/h, it is not a pedelec pursuant to guideline 2002/2004/EG, and it therefore requires type and individual vehicle approval.

The following applies:

- Speed pedelecs are legally categorised as mopeds in class L1e.
- On journeys using motor support, you are not permitted to ride over 20 km/h.
- The motor support switches off when you reach approx. 45 km/h.
- Please inform yourself about the applicable regulations regarding wearing a helmet. However, for safety reasons you should never ride without a helmet
- A driving license is required. Please inform yourself about the applicable regulations regarding licenses. It is possible that a minimum age is enough to be allowed to ride without a driving license.
- If you have a national driving license for a car, the required permission may be covered by this.
- The obligation to wear a helmet is being discussed in many countries. Please inform yourself about the applicable regulations before using your bike. For your own safety you should never ride without a helmet!

These regulations also apply to you if you are within the scope of the European Union. Other regulations may apply in other countries, including other European nations in isolated cases. Please inform yourself about the applicable legislation for using your pedelec!

## Speed pedelecs and cycle paths



If you use your speed pedelec like you would a normal bicycle, without the support of the electric motor, you are permitted to use all cycle paths without limitation. The following

applies if you use the motor:

Similar to with mopeds, you have to use cycle paths outside of urban areas. If this is not permitted, this is displayed by an additional sign on the cycle path stating: No mopeds.

In urban areas, you are only permitted to use cycle paths which feature an additional sign permitting you to do so.

Please inform yourself about the applicable legislation for you whatever the case.

## Speed switch

Pedelecs are equipped with a speed switch. Your pedelec is not designed to exceed 20 km/h, if you apply the speed switch and do not turn the pedals. That is why you are not legally obligated to wear a helmet with this vehicle.



The additional force from the motor could mean that you travel at a considerably higher speed than you are used to on your bicycle. Please take this into account when familiarising yourself with the speed pedelec!

## Replacing parts on your speed pedelec

Specific components are defined in the approval process which are allowed to be used on this vehicle. In other words, the pedelec is only permitted if your vehicle uses these parts or replacement parts which have been approved for use with your model.

If parts are subsequently changed, please replace these with original parts or replacements which are approved for used on your pedelec, otherwise you must seek individual permission from the TÜV or your local regulatory authority.

### Parts which may be replaced like-for-like or with approved parts are as follows:

- |                 |                         |
|-----------------|-------------------------|
| 1. Frame        | 8. Front light          |
| 2. Fork         | 9. Rear light           |
| 3. Motor unit   | 10. Number plate holder |
| 4. Battery      | 11. Side stand          |
| 5. Tyres        | 12. Handlebars          |
| 6. Rims         | 13. Stem                |
| 7. Brake system |                         |

 If you send your pedelec's battery by post, you have to adhere to strict requirements. Please ask the manufacturer or your specialist retailer about the applicable regulations.

If you transport your pedelec by car, please remove the battery and transport it separately.

## Warranty and liability in the case of defects

 In all nations which apply EU law, the common conditions for warranty/liability for material defects apply. Please inform yourself about the applicable national regulations in your specific country.

Under EU law, the seller accepts liability for material defects for at least two years after the date of sale. This also covers defects which already existed at the time of sale/change of ownership. In fact, if material defects occur within the first six months, the assumption is made that these already existed at the time of sale.

One precondition for the seller assuming this liability is that the product's use and maintenance was in line with all conditions stipulated. These are outlined in the pages of this operating manual and in the supplied instructions from the component manufacturers.

In most cases, the customer can first request subsequent fulfilment.

If repair fails conclusively, which is the assumption after two attempts, the customer is entitled to abatement or cancellation of the contract.

Liability for material defects does not cover normal wear occurring from the product's intended purpose. Components in the motor and deceleration system as well as tyres, light system and contact points of the rider with the bicycle are all subject to use-related wear, as well as the battery in pedelecs and e-bikes.

If the manufacturer of your bicycle or pedelec/e-bike provides other additional guarantees, these are listed on page U7. Please consult the respective warranty terms for more information

on the conditions of these and of any possible claims under these.

 In the case of a defect/possible liability claim, please contact your specialist retailer. We recommend filing all purchase receipts and inspection reports as proof for your records

# Environmental protection tips

## General care and cleaning products

Please take the environment into account when caring for and cleaning your bicycle. You should use care and cleaning products which are biodegradable wherever possible. Please ensure that no cleaning fluid enters the drainage system. When cleaning the chain, use a suitable chain cleaning tool and dispose of chain lubricant properly at a suitable waste disposal site.

## Brake cleaner and lubricants

Take the same approach to using brake cleaner and lubricants as you do to general care and cleaning products.

## Tyres and inner tubes

Tyres and inner tubes are not residual waste or domestic rubbish and have to be disposed of at your local recycling centre.

## Carbon parts and frames

Carbon parts and frames consist of carbon fibre matting stuck together in layers. We recommend allowing your specialist retailer to dispose of any discarded carbon parts.

## Batteries from pedelecs and e-bikes

Batteries belonging to pedelecs and e-bikes should be treated as hazardous and are therefore subject to compulsory special labelling. They have to be disposed of by specialist retailers or manufacturers.

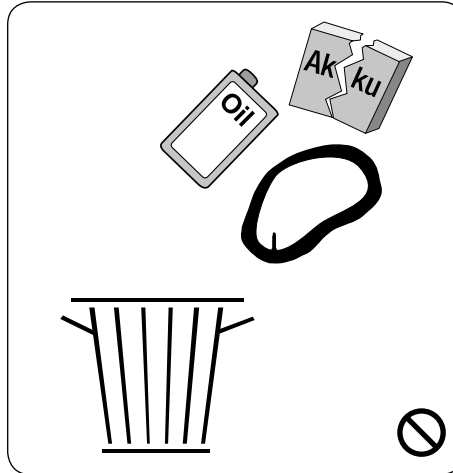



# Inspections

During the next inspection special care should be taken for:

---

---

---

---

---

Parts that should be changed:

---

---

---

---

---

Problems that occurred:

---

---

---

---

---



<p>1st inspection After approx. 200 kilometres</p> <p>Work done:</p> <hr/> <hr/> <hr/> <hr/> <hr/> <hr/> <hr/> <hr/> <p>Materials used:</p> <hr/> <hr/> <hr/> <hr/> <hr/> <hr/> <hr/> <hr/> <p>Date, signature                      Retailer stamp</p>	<p>2nd inspection After approx. 1000 kilometres</p> <p>Work done:</p> <hr/> <hr/> <hr/> <hr/> <hr/> <hr/> <hr/> <hr/> <p>Materials used:</p> <hr/> <hr/> <hr/> <hr/> <hr/> <hr/> <hr/> <hr/> <p>Date, signature                      Retailer stamp</p>	<p>3rd inspection After approx. 2000 kilometres</p> <p>Work done:</p> <hr/> <hr/> <hr/> <hr/> <hr/> <hr/> <hr/> <hr/> <p>Materials used:</p> <hr/> <hr/> <hr/> <hr/> <hr/> <hr/> <hr/> <hr/> <p>Date, signature                      Retailer stamp</p>
--	---	---



<p>4th inspection</p> <p>Work done:</p> <hr/> <hr/> <hr/> <hr/> <hr/> <hr/> <hr/> <hr/> <p>Materials used:</p> <hr/> <hr/> <hr/> <hr/> <hr/> <hr/> <hr/> <hr/> <p>Date, signature                      Retailer stamp</p>	<p>5th inspection</p> <p>Work done:</p> <hr/> <hr/> <hr/> <hr/> <hr/> <hr/> <hr/> <hr/> <p>Materials used:</p> <hr/> <hr/> <hr/> <hr/> <hr/> <hr/> <hr/> <hr/> <p>Date, signature                      Retailer stamp</p>	<p>6th inspection</p> <p>Work done:</p> <hr/> <hr/> <hr/> <hr/> <hr/> <hr/> <hr/> <hr/> <p>Materials used:</p> <hr/> <hr/> <hr/> <hr/> <hr/> <hr/> <hr/> <hr/> <p>Date, signature                      Retailer stamp</p>
---	---	---



# Notes





# Notes



# Handover documentation

The bicycle listed in the bicycle identification on the right was assembled properly and was delivered to the customer ready-to-use.

## Functional checks for the following components:

- Wheels: spoke tension, sturdiness, concentricity, correct tyre pressure
- All screw joints: secure, correct mounting torque
- Gear system
- Brake system
- Seat position adjusted to the rider
- Suspension adjusted to the rider
- The following components were assembled and checked separately:

---

---

---

- The assembling/inspecting party completed a test ride
- The customer was instructed on how to use the bicycle
- Function of the right front brake
- Function of the left front brake

\_\_\_\_\_  
Date                      Signature assembling party / retailer stamp:

## The following operating manuals were supplied and explained:

- Bicycle
- Plus:  Pedelec
- Gear system
- Battery
- Brake system
- Motor
- Belt drive
- Operating parts
- Other documentation:

---

---

---

Authorized for trailers                       yes                       no

Maximum permissible weight \_\_\_\_\_

(Weight of the bicycle + rider + baggage + trailer)

## Customer/recipient

Name \_\_\_\_\_

Address \_\_\_\_\_

Postal code, Town/City \_\_\_\_\_

e-mail \_\_\_\_\_

\_\_\_\_\_  
Date                      Signature Recipient



# Bicycle identification

Bicycle manufacturer ASI Corp

Brand SE

Model \_\_\_\_\_

Frame height/size \_\_\_\_\_

Colour \_\_\_\_\_

Frame number \_\_\_\_\_

Fork \_\_\_\_\_

Serial number \_\_\_\_\_

Gear system \_\_\_\_\_

Special features \_\_\_\_\_

Purchase date \_\_\_\_\_

Owner \_\_\_\_\_

Address \_\_\_\_\_

\_\_\_\_\_

Date/Signature \_\_\_\_\_

Supplied by (retailer stamp):

In the case of change of ownership:

Owner \_\_\_\_\_

Address \_\_\_\_\_

\_\_\_\_\_

Date/Signature \_\_\_\_\_

-----  
Line up this edge when copying



# Notes

## **Please unfold!**

Please note the bicycle identification  
and handover documentation!





SE Bikes is a trademark of ASI Corp

[www.advancedsports.com](http://www.advancedsports.com)

© ASI